

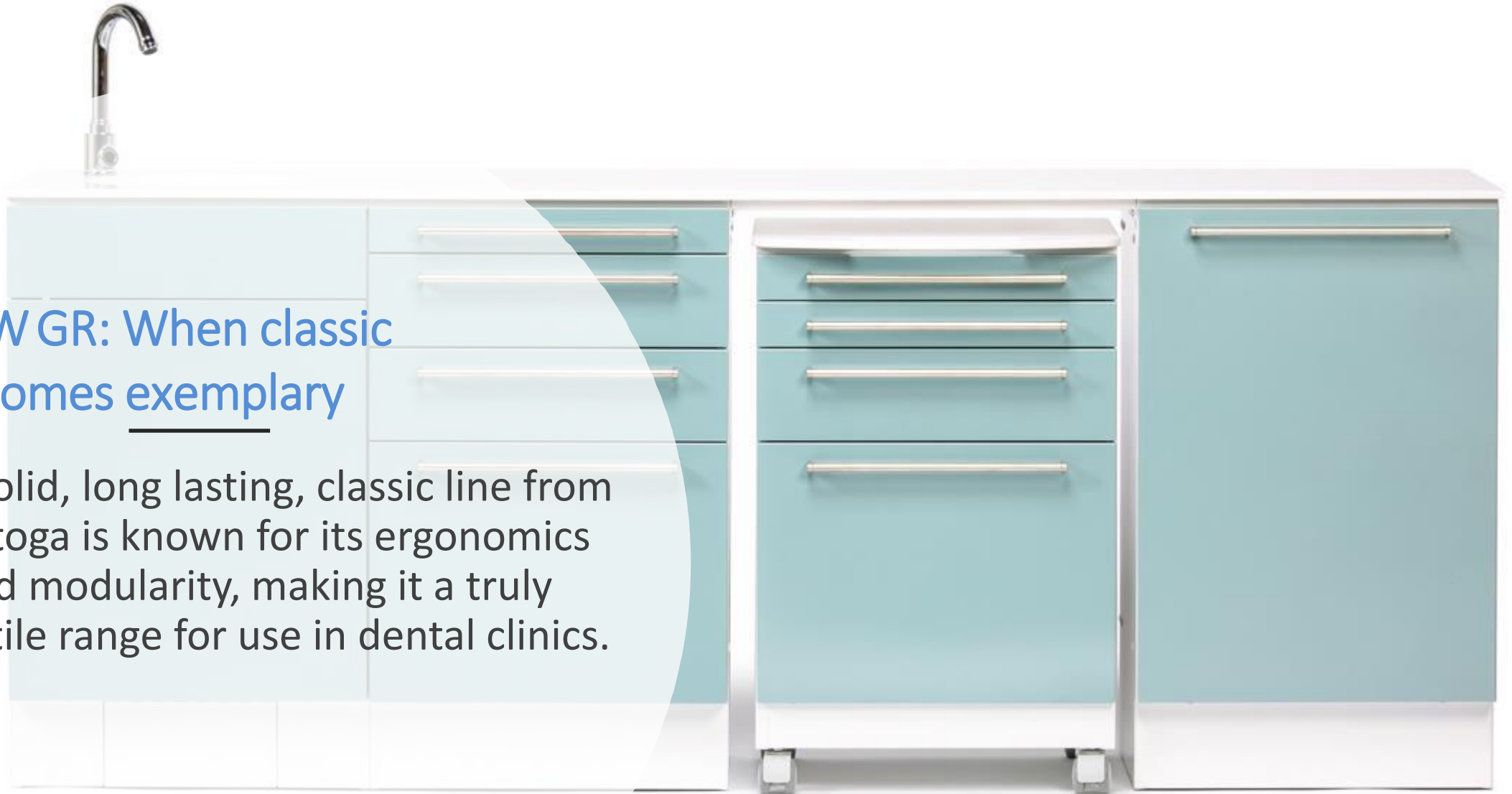

NEW GR



NEW GR: When classic becomes exemplary

This solid, long lasting, classic line from Saratoga is known for its ergonomics and modularity, making it a truly versatile range for use in dental clinics.

Alternative **CB LINE** version with gasket

 **SARATOGA**

Reliability beyond design

The first choice for professionals looking for reliable, long-lasting furniture developed and manufactured for practicality and made in Italy design.

Alternative **CB LINE** version with gasket

 **SARATOGA**



Your ally, always

Solutions created and produced to improve operations, from the overall profile down to technical detail. The NEW GR line is produced exclusively from high-quality tried and tested materials.

Alternative **CB LINE** version with gasket

Maximum hygiene guaranteed

Hygiene is one of the essential aspects of a line designed to simplify dental work and guarantee professionals a high level of performance.

The version with extending stainless steel foot also guarantees maximum hygiene.

Alternative **CB LINE** version with gasket

 **SARATOGA**



Modularity and functionality

—
This modular range adapts to a vast array of planning projects. Space is shaped and becomes an indispensable ally.

Alternative **CB LINE** version with gasket

 **SARATOGA**



Saratoga Spa, Via Savio 7, 33170 Pordenone, Italy

T. +39 0434 572600 info@saratogadental.it

www.saratogadental.it



sign

Sign

Il progetto Sign si amplia includendo una rivisitazione della gamma classica Saratoga secondo una filosofia che si può definire ultra modulare: l'obiettivo è di consentire al professionista di personalizzare il suo arredo professionale secondo il suo gusto estetico, le sue esigenze, il budget disponibile.

Tale progetto deriva dall'implementazione della lean manufacturing, che ha permesso a Saratoga di ottimizzare i flussi produttivi e di garantire la massima flessibilità nella personalizzazione. Il cuore del progetto è la monoscocca che, grazie all'estesa gamma di allestimenti disponibili, si può "vestire" come un abito sartoriale in 256 declinazioni differenti.

The Sign project widens its horizon including a reinterpretation of the classic Saratoga range according to a "ultra modular" philosophy: the aim is to enable the practitioner to customize his professional furniture according to the aesthetic, to the needs, or the budget.

This project stems from the implementation of lean manufacturing, which allowed Saratoga to optimize production flows and to ensure maximum flexibility in customization.

The heart of the project is the unique body that, thanks to the extensive range of included features, can be "dressed" like a tailored suit in 256 different variations.

CORPORATE IDENTITY

Da oltre 40 anni saratoga è specializzata nella produzione di arredi tecnici e sale di sterilizzazione con un focus particolare al design e all'ergonomia. Il sito produttivo si estende su un terreno di 15.000mq ed include le più avanzate tecnologie per la fabbricazione e la verniciatura dei nostri mobili. L'azienda è certificata UNI EN ISO 9001 dal 14 novembre 2002.

Saratoga has been a leading company in the field of professional dentistry equipment for dental clinics and sterilization rooms with a special focus on design and ergonomics, for more than 40 years. The production site covers an area of 15.000 sqm and includes the latest technology for the manufacture and painting of our furniture. The company is certified UNI EN ISO 9001 since November 14, 2002.

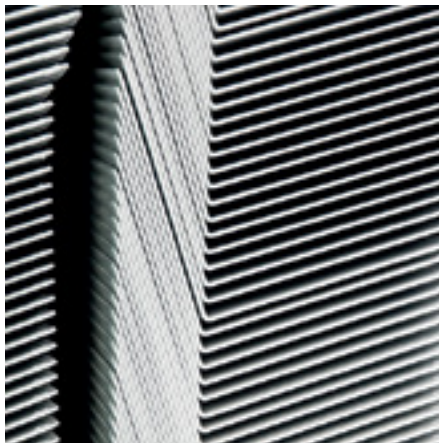

QUALITÀ
QUALITY





BENESSERE
HEALTH

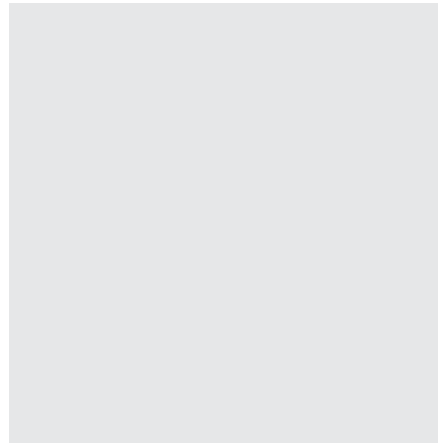
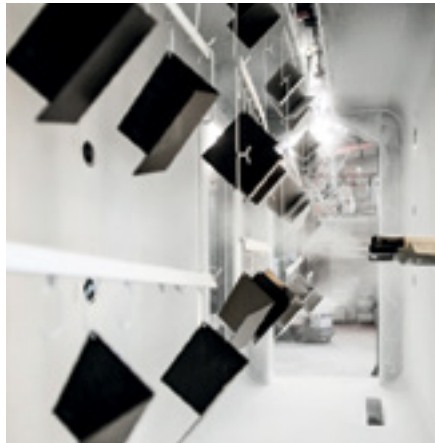

INNOVAZIONE
INNOVATION



SERVIZIO
SERVICE



MATRIX SYSTEM

La scocca unica di SIGN si può vestire in 256 modi diversi ed è disponibile in tutti i colori RAL e ARC della gamma Saratoga. E' possibile scegliere

- *il tipo di appoggio: fino a terra, rialzato o sospeso*
- *la tipologia di frontali: Hi-Macs, metallo, alluminio con o senza maniglia integrata*
- *il piano di lavoro: Hi-Macs, vetro 12mm, laminato, HPL*

e molto altro ancora: rubinetti, lavelli, maniglie e una moltitudine di altri accessori sono a disposizione per comporre il mobile ideale!

The unique body of SIGN can get dressed in 256 different ways and is available in all RAL and ARC colors of Saratoga range. It is possible to choose

- *the type of support: till the floor, raised or suspended*
- *the type of front: Hi-Macs, metal, aluminum, with or without built-in handle*
- *the work top: Hi-Macs, 12mm glass, laminate, HPL*

and much more: faucets, sinks, handles .. and a great number of other accessories are available to make the perfect furniture up!



sign

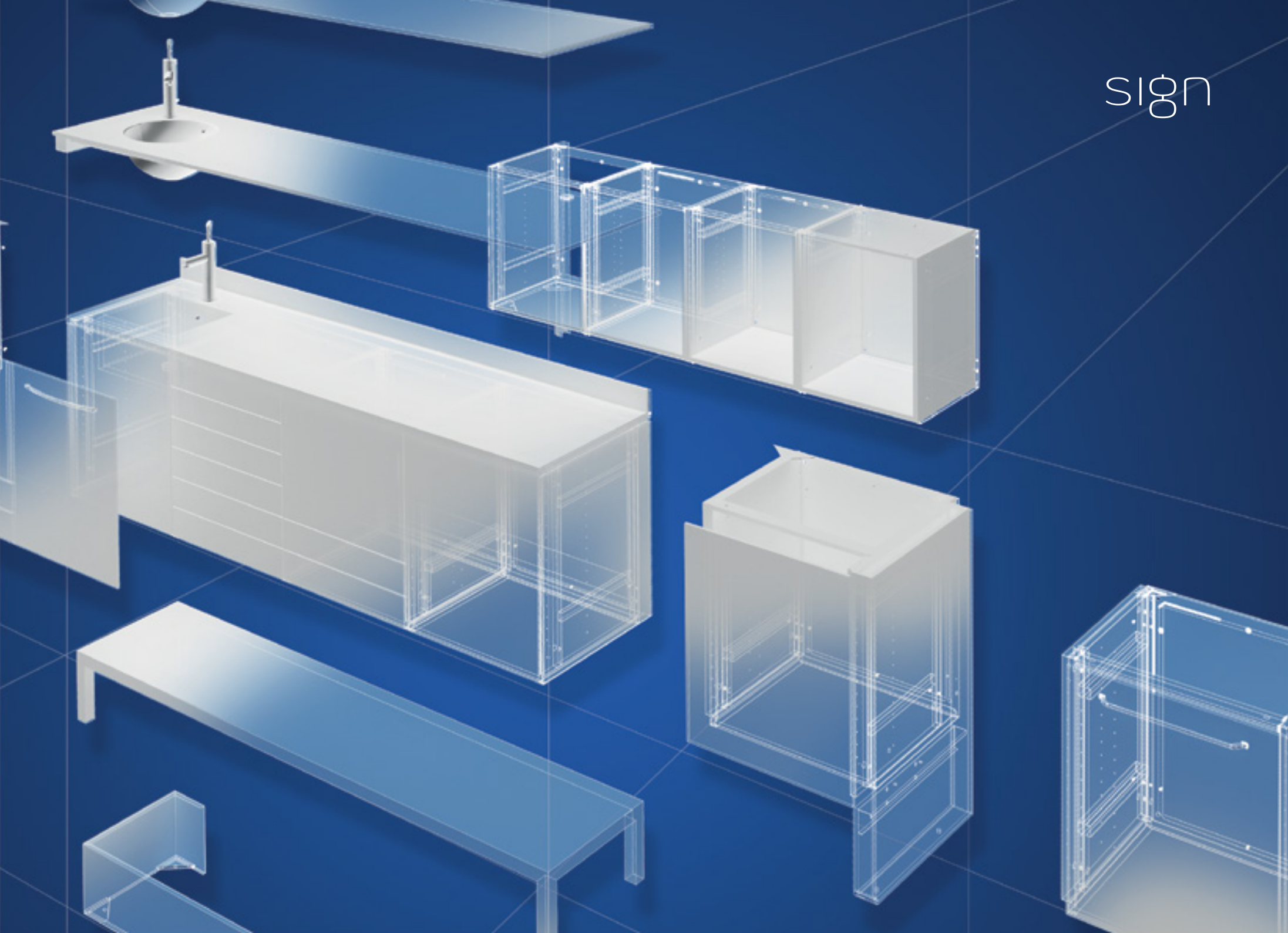

SIGN B

I modelli Sign si adattano allo stile dell'ambiente e sono proposti in 3 diverse configurazioni: fino a terra, rialzata e sospesa.

Nella versione fino a terra è possibile scegliere tra la semplicità dello zoccolo e la praticità del cassettone.

The SIGN models adapt themselves to the style of the surrounding environment, and feature three different configurations: till the floor, raised and suspended

In the "till the floor" version you can choose between the plinth simplicity and drawers practicality

sign

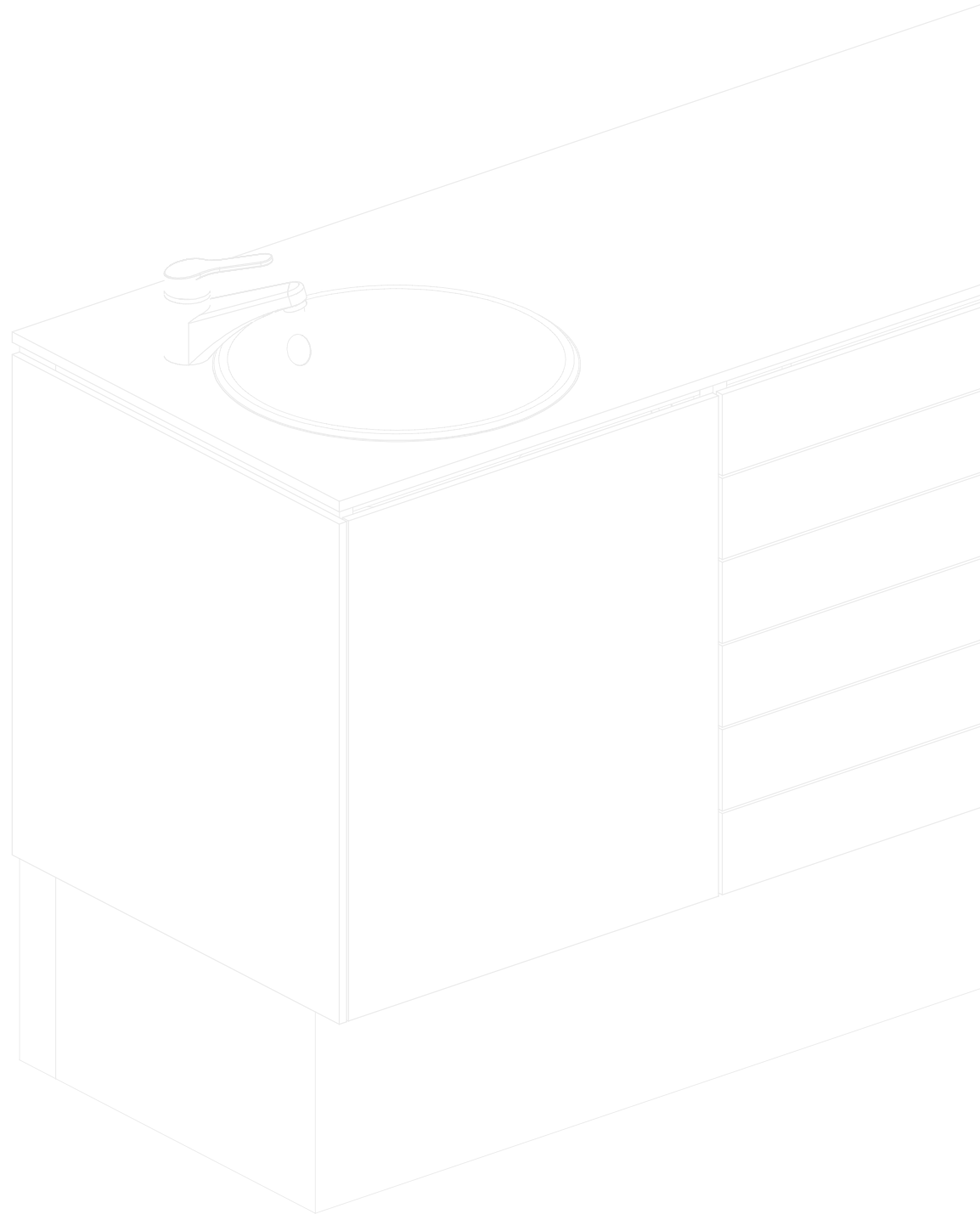

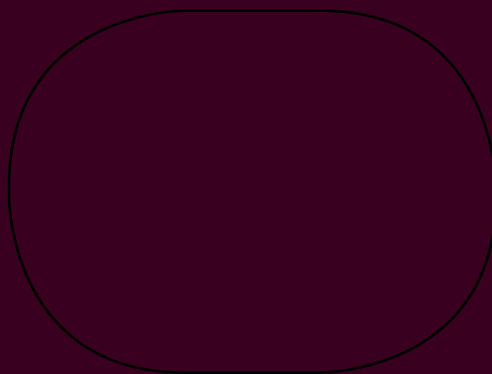
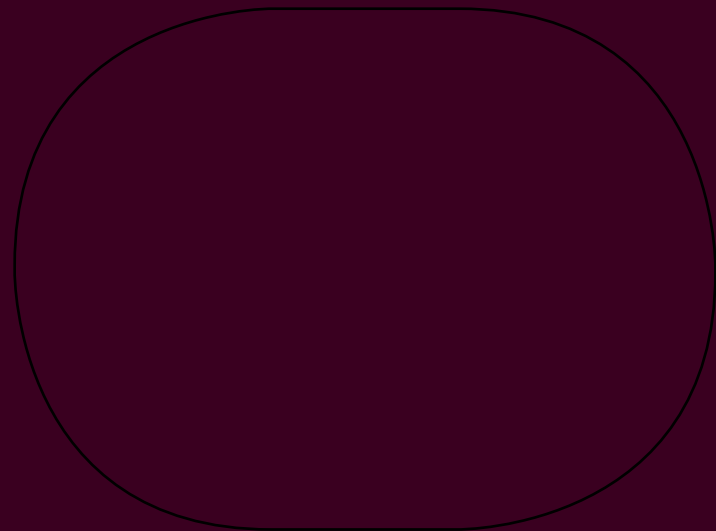

*Piano di lavoro:
Hi-Macs Alpine White
Frontali: metallo*

*Worktop:
Hi-Macs Alpine White
Fronts: metal*

B

01



02



01. Vasca in inox filo piano
02. Zoccolo in metallo

01. Stainless steel round sink fixed under the top
02. Metal plinth



sign

SIGN F

La versione rialzata si concretizza nell'utilizzo di un telaio unico in metallo con piedini oppure di un supporto dalla caratteristica forma "a slitta".

The raised version is equipped with a unique metal frame with feet or with a "slide" shape support

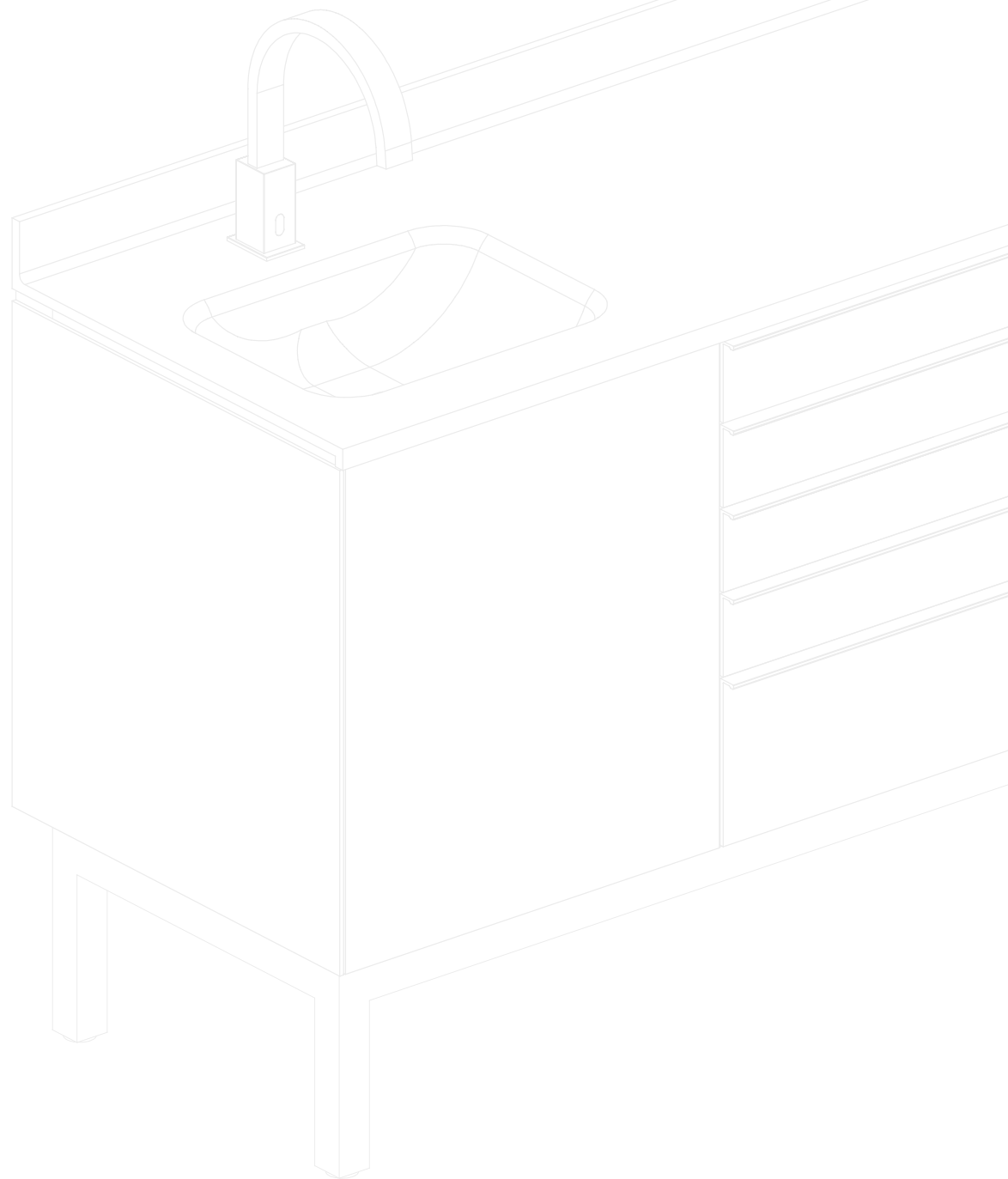

sign

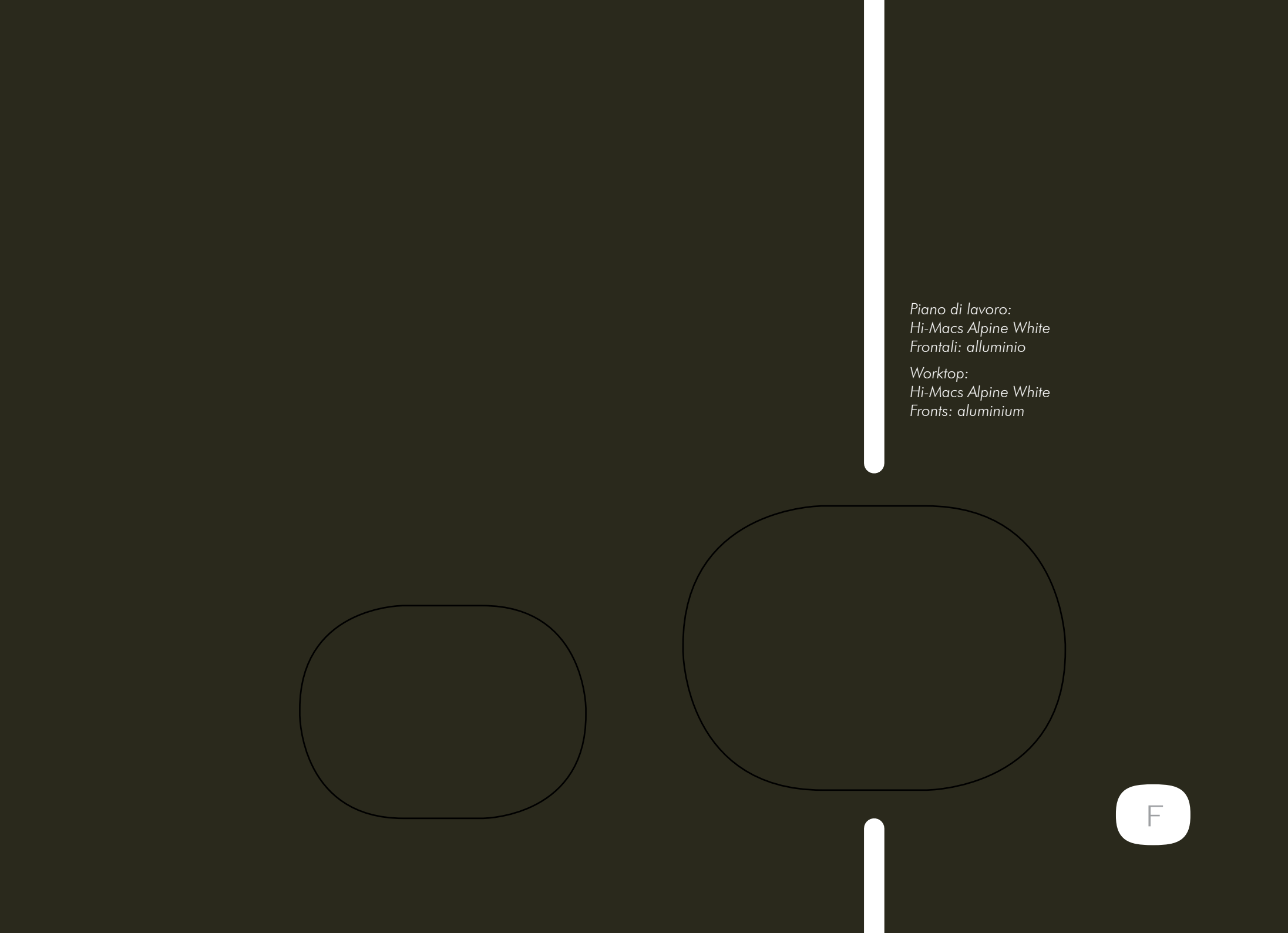

*Piano di lavoro:
Hi-Macs Alpine White
Frontali: alluminio*

*Worktop:
Hi-Macs Alpine White
Fronts: aluminium*

F

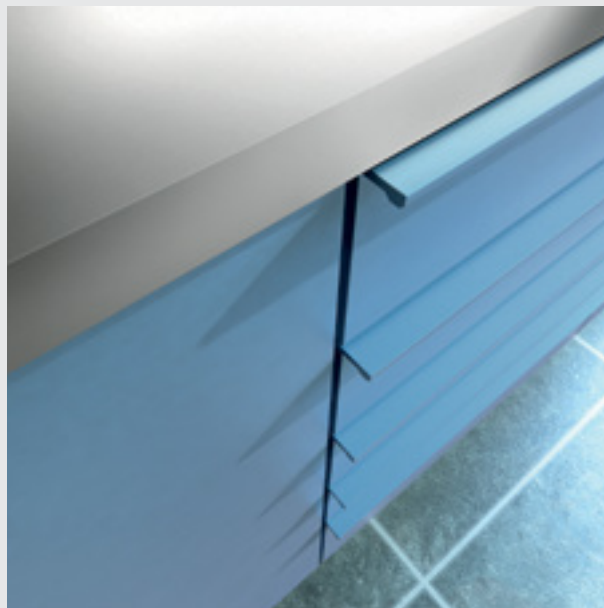

Frontale in alluminio con maniglia integrata
Aluminium fronts with integrated handle



sign

SIGN F

La nuova linea Sign è concepita pensando ad un'ampia possibilità di personalizzazione, dai materiali ai colori.

The new SIGN line was developed to offer a wide range of customization possibilities, from materials to colors

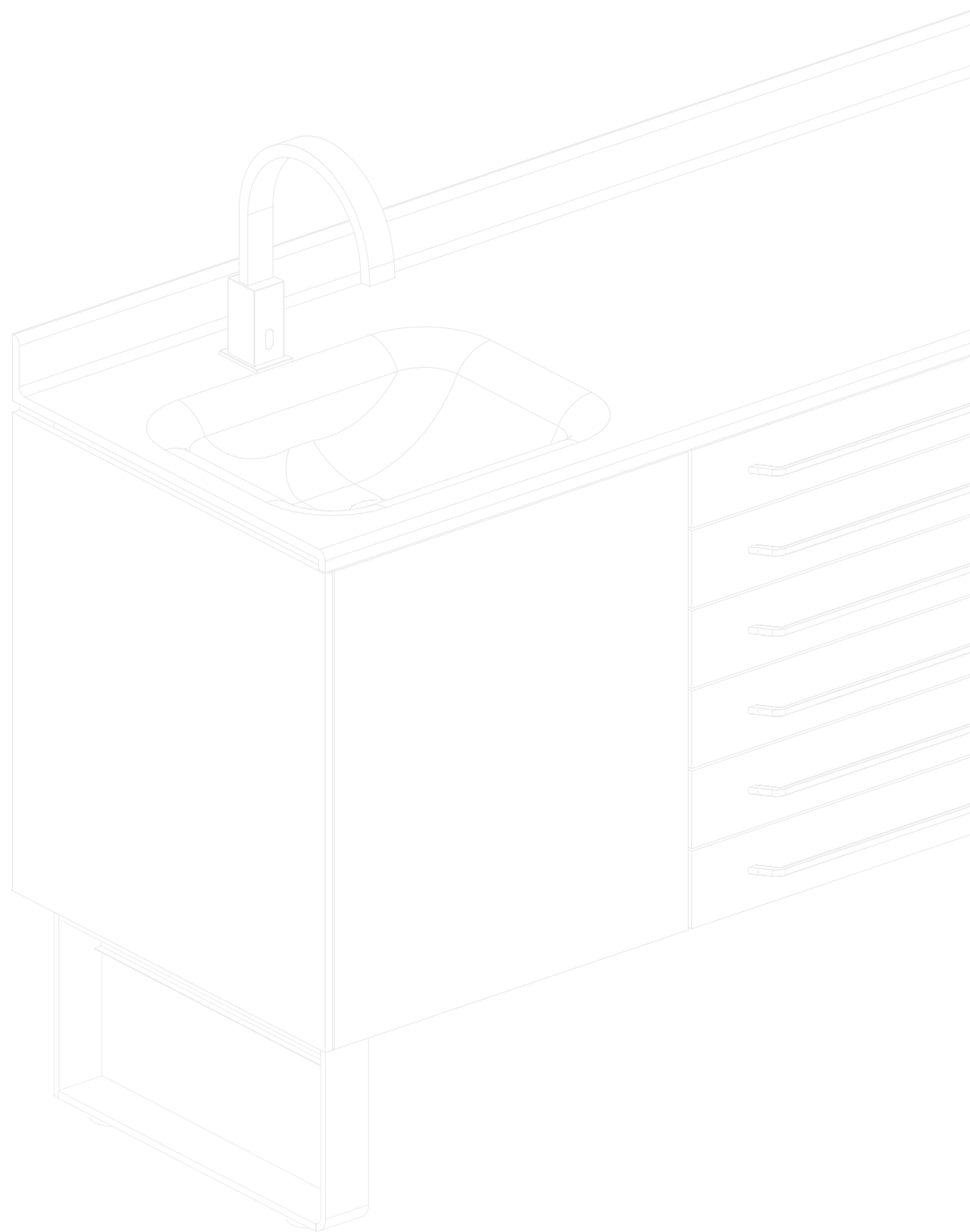

sign

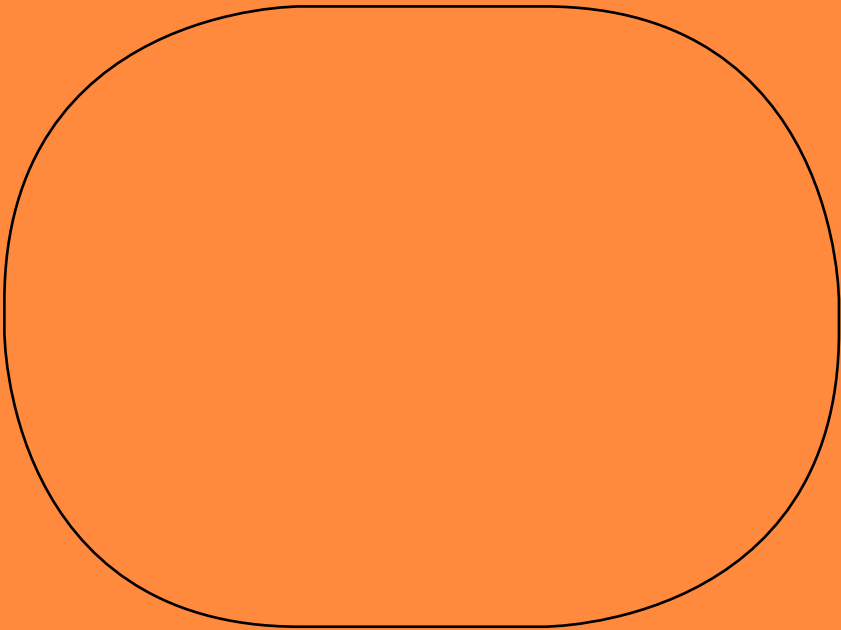

*Piano di lavoro:
Hi-Macs Alpine White
Frontali: alluminio*

*Worktop:
Hi-Macs Alpine White
Fronts: aluminium*



01

01. Alzatina integrata e raggiata, frontale da 12 mm raggiato
02. Supporto verniciato color cromo

01. Shaped and integrated upstand, 12mm shaped front
02. Chromo painted support



02



sign

SIGN S

*Un elegante mobile sospeso
che si contraddistingue
per garantire la massima igiene:
lo stile si lega alla funzionalità.*

*An elegant suspended module
that ensures maximum hygiene:
the style is tied to functionality.*

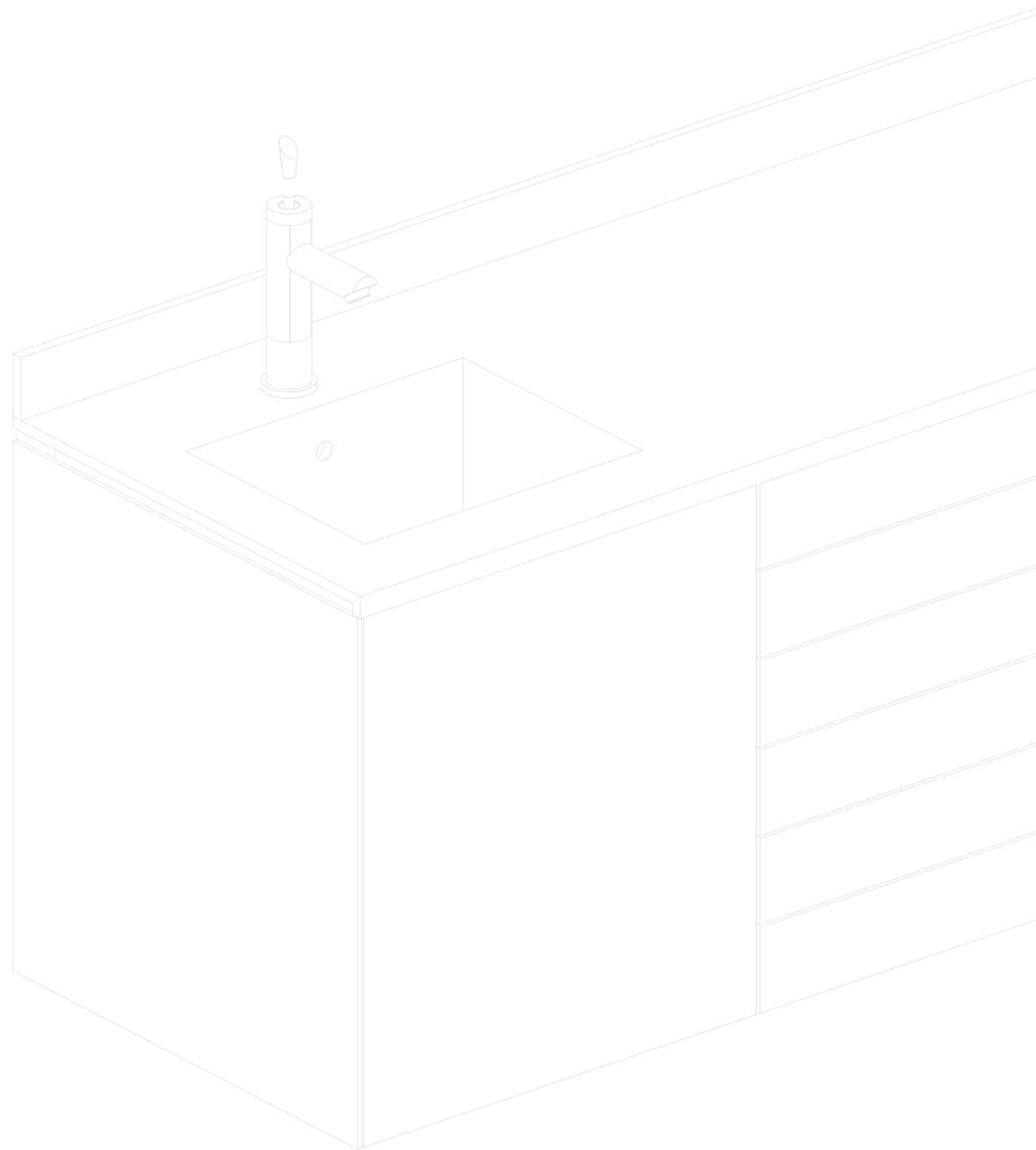

sign

*Piano di lavoro:
Hi-Macs Alpine White
Frontali: Hi-Macs Fiery Red*

*Worktop:
Hi-Macs Alpine White
Fronts: Fiery Red Hi-Macs*

S

01



02

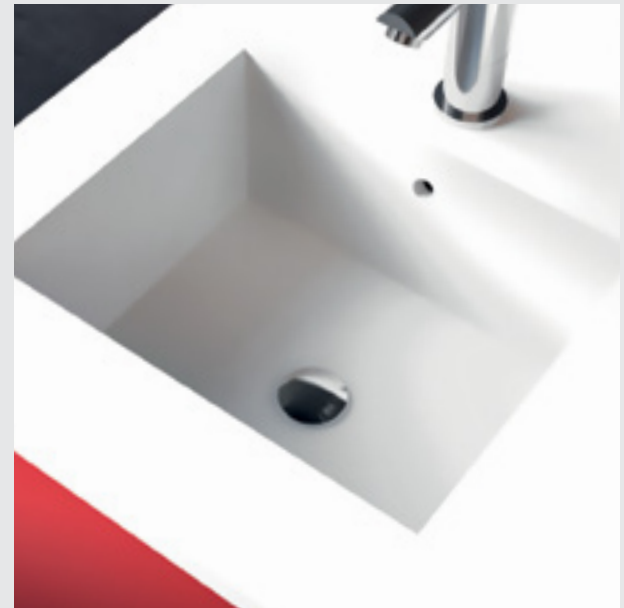

01. Anche i frontali di ante e cassetti possono essere realizzati in Hi-Macs
02. Vasca quadrata in Hi-Macs, applicata

01. The front panel of doors and drawers can also be made of Hi-Macs.
02. Square Hi-Macs sink



sign

SIGN+ B

In tutte e tre le versioni l'elemento protagonista che connota la linea e firma il suo stile è il componente a slitta che disegna il mobile dal top a terra, lungo il suo profilo.

In all three versions the core element that distinguishes the line and signs its style is the slide component that traces the cabinet from the top down to the ground, along its outline.

sign



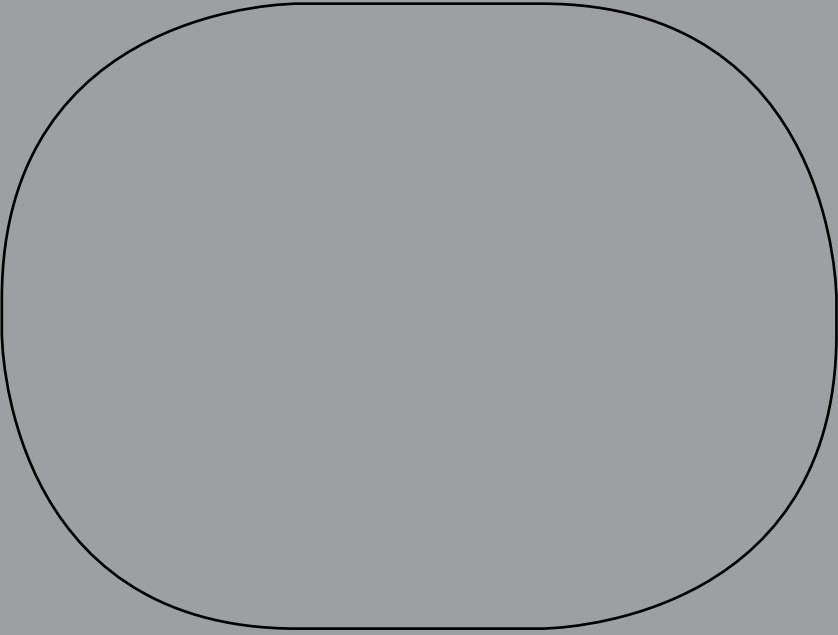

*Piano di lavoro:
Hi-Macs Alpine White
Frontali: alluminio*

*Worktop:
Hi-Macs Alpine White
Fronts: aluminium*

+B



Le superfici, le maniglie integrate, la continuità dei profili arrotondati, i fianchi integrati alla slitta in modo compatto sono concepiti per avere un'ottimale pulizia del mobile.

The surfaces, the built-in handles, the sides incorporated into the slide in a compact fashion are designed for easy and optimal cleaning of the dental cabinet.



sign

SIGN+ B

*Frontali e fianchi dei mobili
sono disponibili in tinte RAL
a scelta o in Hi-Macs
nella gamma colori Saratoga*

*The front panels and the sides
are available in the RAL color
of your choice, or made of Hi-Macs
in the Saratoga color range.*

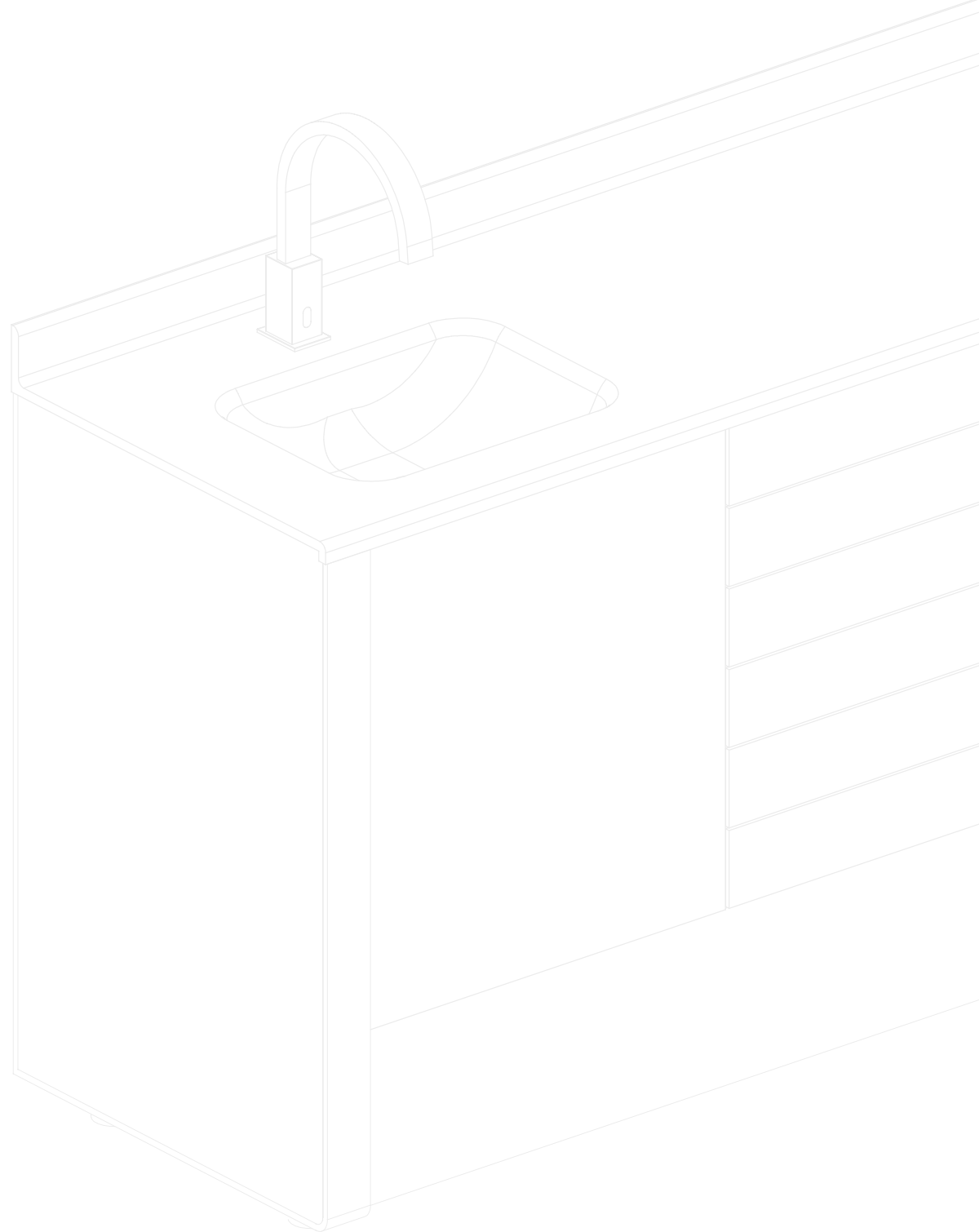

sign

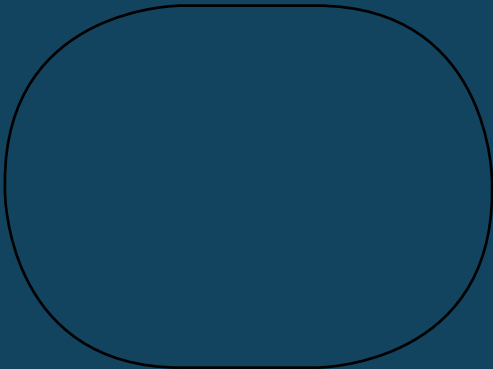
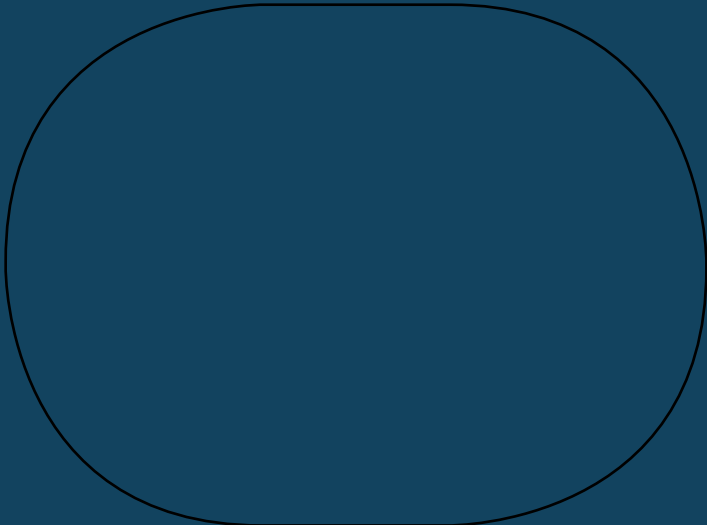

*Piano di lavoro:
Hi-Macs Alpine White
Frontali: metallo*

*Worktop:
Hi-Macs Alpine White
Fronts: metal*

+B

Elegante e contemporanea, SIGN, nello stile delle linee Saratoga, si adatta con carattere e leggerezza ad ogni ambiente. La linea Sign può essere abbinata alle numerose vetrine e moduli igiene disponibili.

Stylish and smart, SIGN, in the style of Saratoga lines, fits with character and lightness to any dental cabinet.

The Sign line can be matched to the wide range of wall cabinets and hygiene modules available.





sign

SIGN+ F

La slitta è il vero tratto distintivo di ogni modello SIGN e può essere personalizzata nel colore.

The slide is the real distinguishing trait of all SIGN models, and its color can be personalized at will

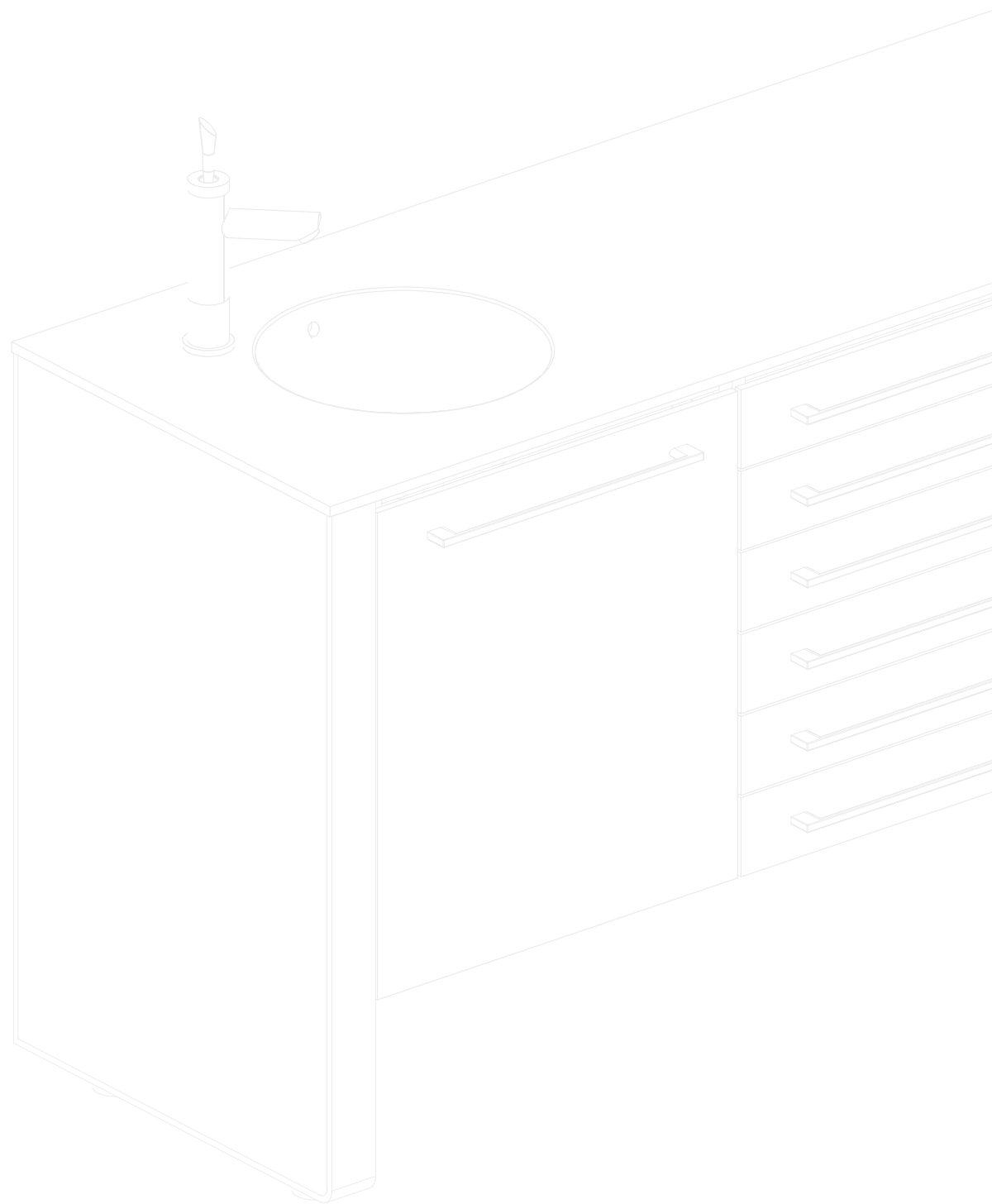

sign

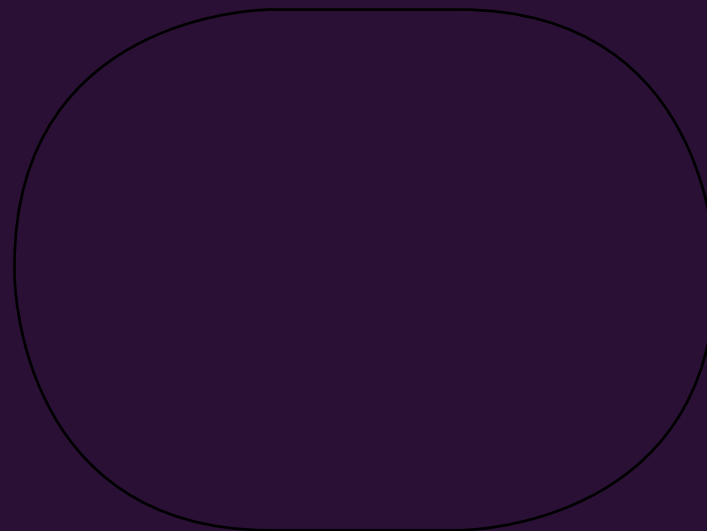

*Piano di lavoro:
Hi-Macs Alpine White
Frontali: metallo*

*Worktop:
Hi-Macs Alpine White
Fronts: metal*



01



02



01. Vasca tonda integrata
02. Piano in Hi-Macs senza alzatina

01. Integrated round sink
02. Hi-Macs Worktop without upstand



sign

SIGN+ S

L'assenza di spigoli, i bordi arrotondati, le superfici complanari tra loro e la slitta che riprende lo stesso raggio di curvatura dal top all'appoggio a terra, donano leggerezza al mobile, che richiama un elegante stile vintage.

The absence of sharp corners, the rounded edges, the surfaces coplanar with each other and the slide with the same curvature radius from the top to the part resting on the ground provide lightness to the piece of furniture, which brings to mind an elegant vintage style.

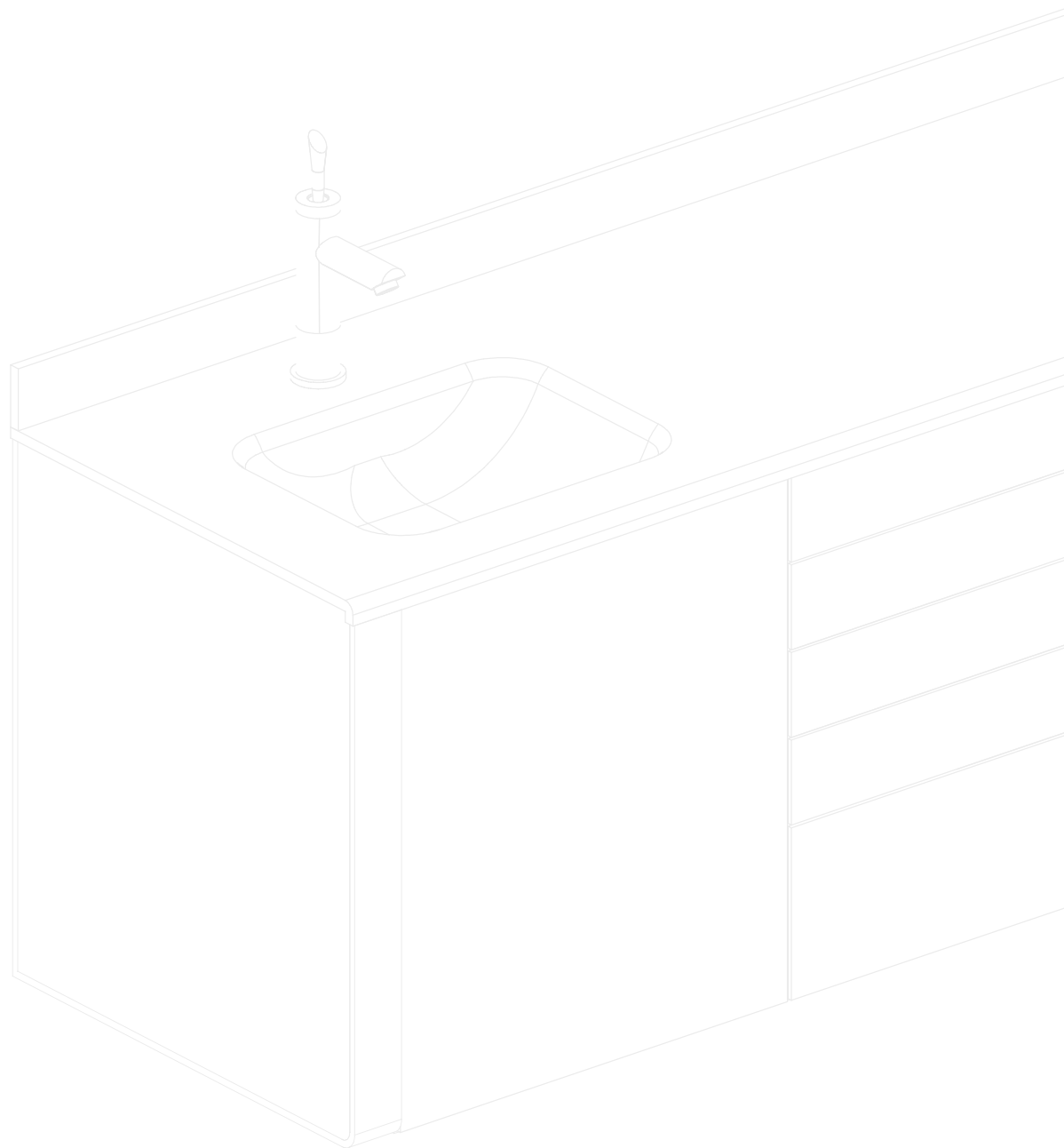

sign

*Piano di lavoro:
Hi-Macs Alpine White
Frontali: alluminio*

*Worktop:
Hi-Macs Alpine White
Fronts: aluminium*

+S

01



02



01. Piano raggiato
02. Frontali in alluminio senza maniglia, apertura elettrica o meccanica.

01. Shaped worktop
02. Aluminium fronts without handle, electrical or mechanical opening.



sign



SARATOGA S.P.A.

Via L. Savio, 7

33170 Pordenone (PN)

Phone: +39 0434 572600

Fax: +39 0434 572477

info@saratogadental.it

sign

saratogadental.it



SARATOGA

THE NEW **GR** HAS (FINALLY) ARRIVED!

01. NEWS

FEATURES OF THE NEW LINE

- ⌚ Available on plinth or on feet
- ⌚ Equipped with blue motion slides
- ⌚ Handles 001 or 004
- ⌚ No gaskets
- ⌚ Available colours:
 Body: only RAL9016
 Front: RAL 9016, RAL 7042, RAL 5010, RAL 6027
Availability to have a customized different colour for front or plinth with an extra charge

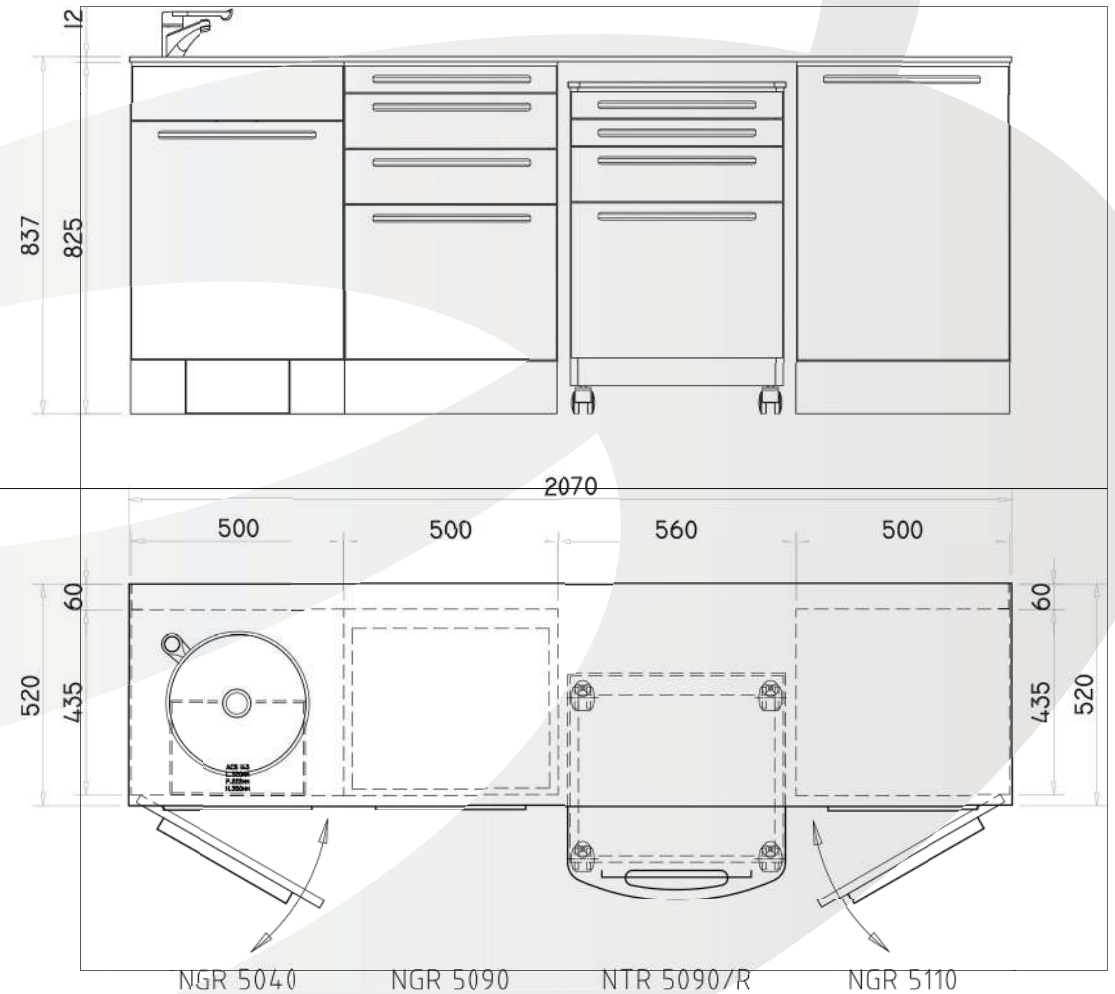





02. MODULARITY



IT IS **POSSIBLE TO CHOOSE** BETWEEN DIFFERENT GR COMPOSITIONS

Sink modules, door, drawers, electromedical, trolley: **choose your favourite composition!**





03. WORK TOP

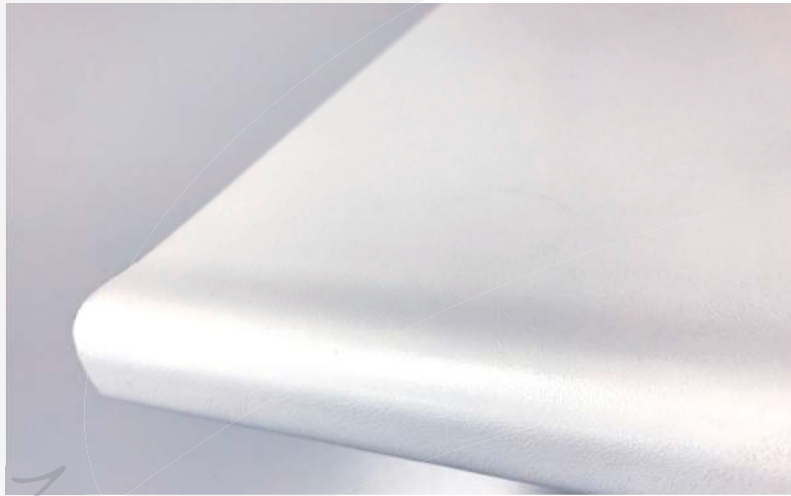

LAMINATE (30 mm) with steel or ceramic sink



HPL (12 mm) with steel or ceramic sink



HI-MACS (12 mm) with integrated sink



VETRO (12 mm) with integrated sink

OPTIONS

04.TAPS AND HANDLES



004 painted or chromed



001 painted or chromed



ACS. 410



ACS. 420

OPTIONS

05. INSERTS

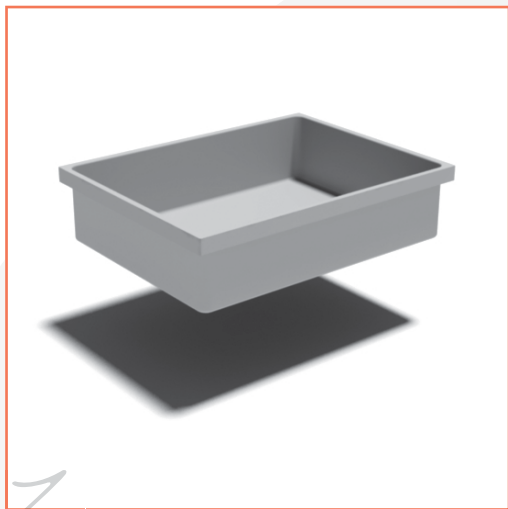

ACS 130/A

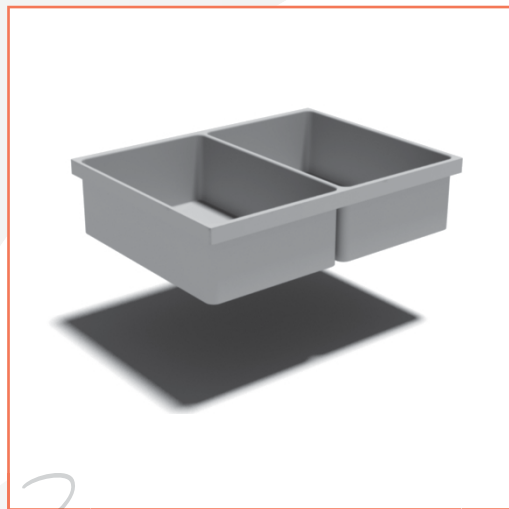

ACS 130/B



ACS 130/C

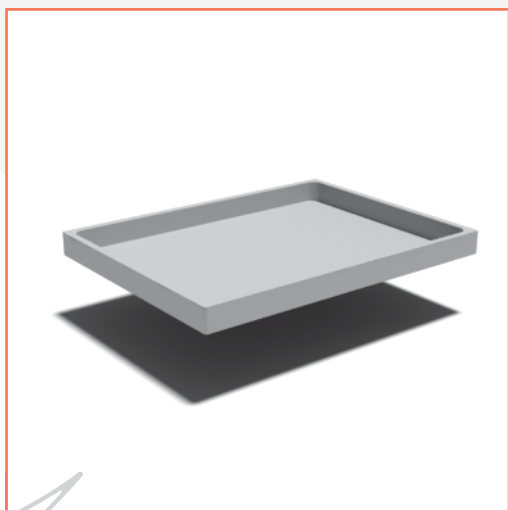

ACS 120

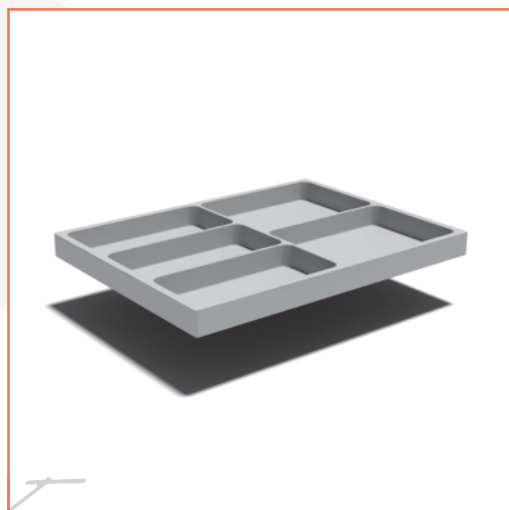

ACS 110/B

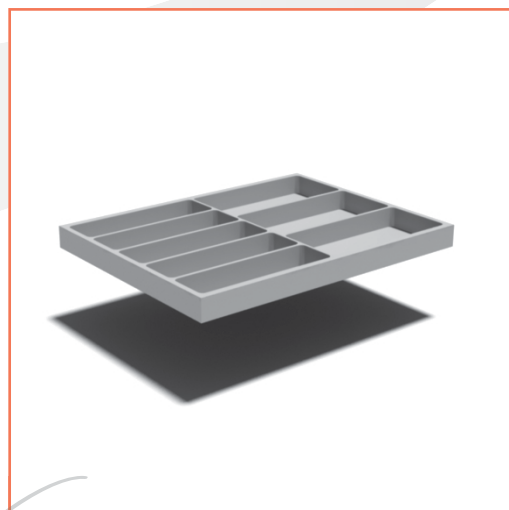

ACS 110

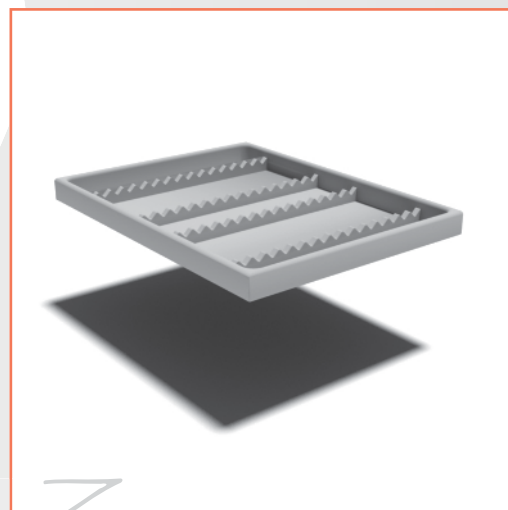

ACS 100

06 . NEW GR: A TIMELESS CLASSIC



The Saratoga classic line, strong and long-lasting:

the real passe-partout of the **dental clinic.**

RELIABILITY - BEYOND DESIGN

The first choice for professionals looking for a trustworthy and long-lasting furniture, designed and realised in Italy.



07. MODULES

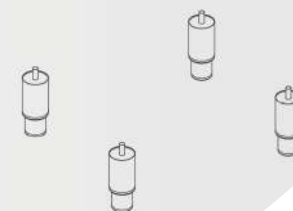
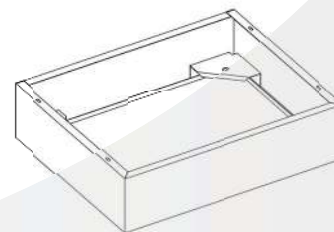
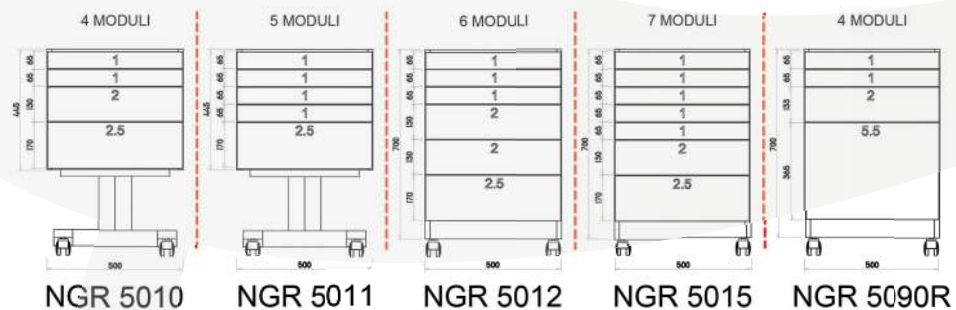
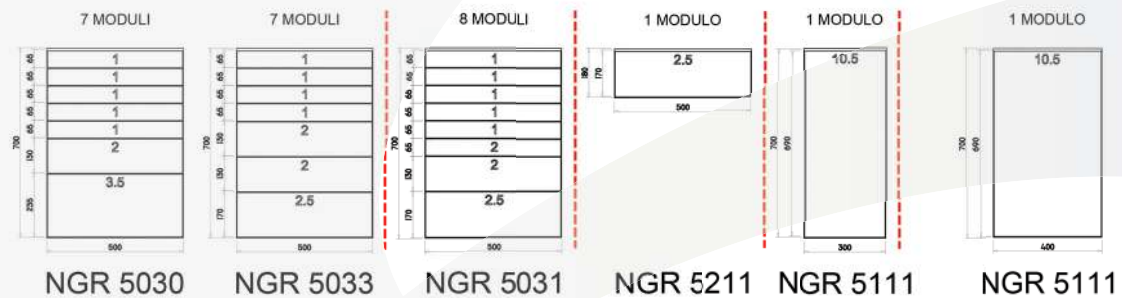
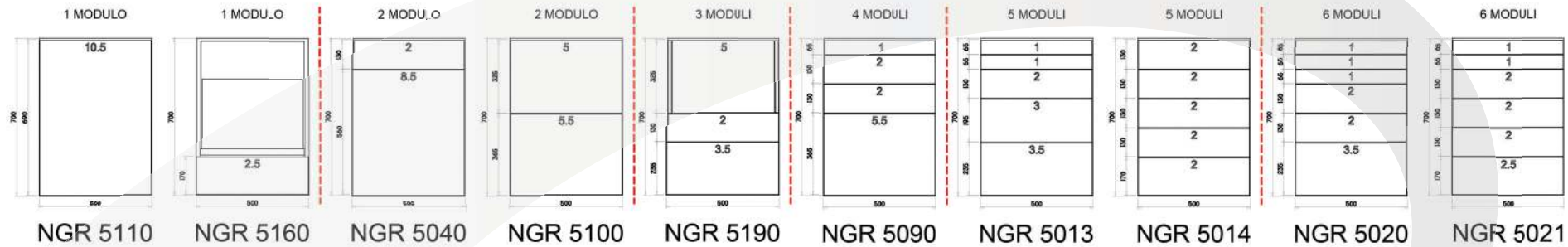



SARATOGA Spa

Via Savio 7 - 33170 Pordenone, Italy - T. +39 0434 572600

info@saratogadental.it

www.saratogadental.it



 SARATOGA





S_ky is the new dispenser designed by Saratoga that adapts to the needs of every dental practice.

In the 1500 or 1000-mm versions, it can contain modules for gloves, masks, cannulas, wipes, as well as soap, disinfectant (with manual or infrared dispensers), glasses and paper roll holders.



SARATOGA

It is possible to choose the position, type and quantity of modules until the internal space is totally filled. Available in standard version or with additional open side compartments.

Extremely compact and functional, S_ky can feature all colors available in the Saratoga range.





mmu

Lateks Pudrali Muavena Eldivleri
Powdered Latex Examination Gloves



mmu Lateks Pudrali Muavena Eldivleri
Powdered Latex Examination Gloves

Uygünlü, ameliyatlarda kullanılmaması için uygundur. Eğer sizde herhangi bir alerjik reaksiyonunuz varsa, bu eldivleri kullanmaktan kaçınınız. Cerrahi eldivlerdir, lütfen steril alanlarda kullanınız. Lateks, alerjik reaksiyona neden olabilir. Lateks, alerjik reaksiyona neden olabilir. Lateks, alerjik reaksiyona neden olabilir.



mmu





 SARATOGA





SARATOGA

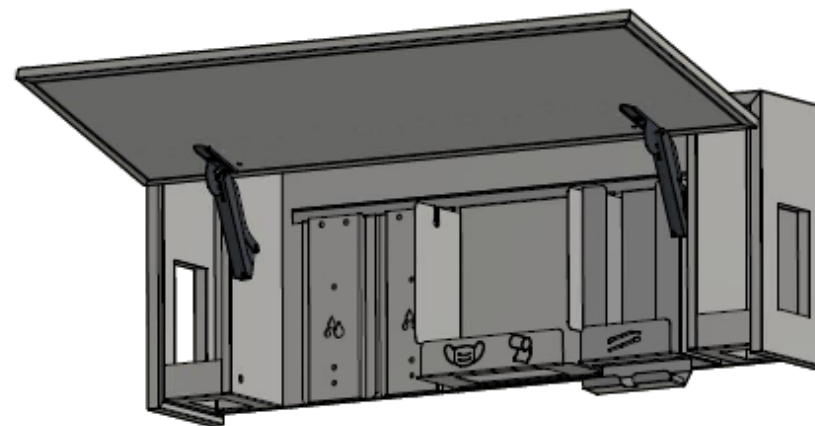
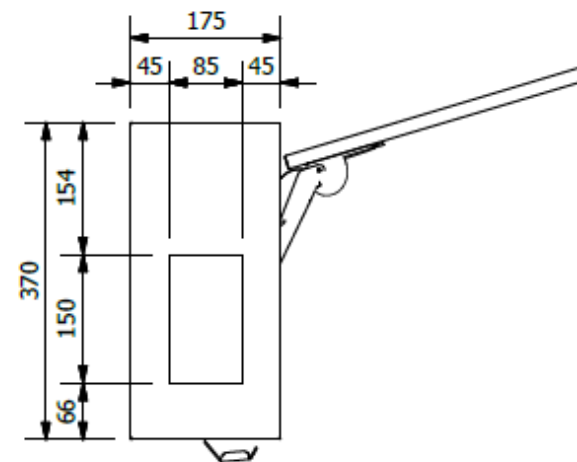
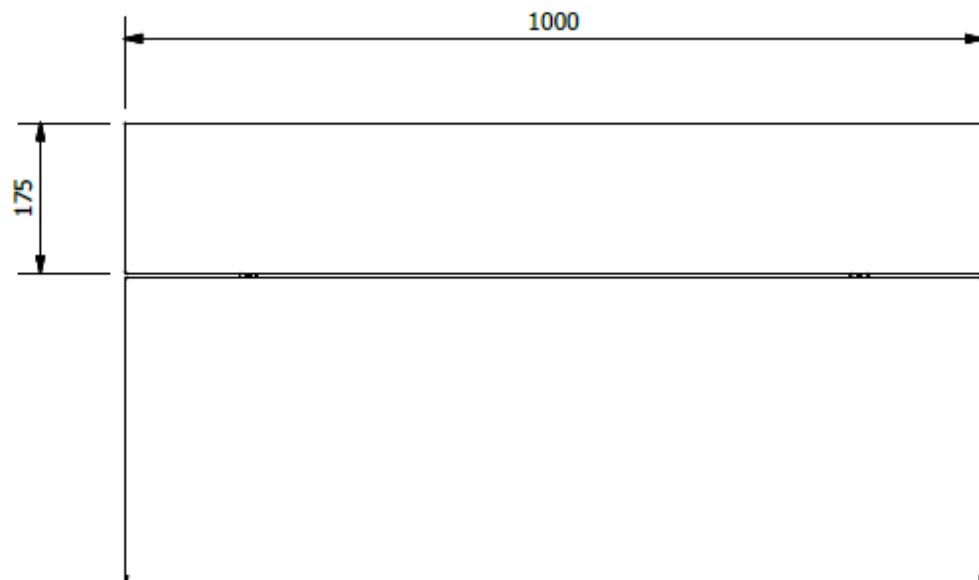
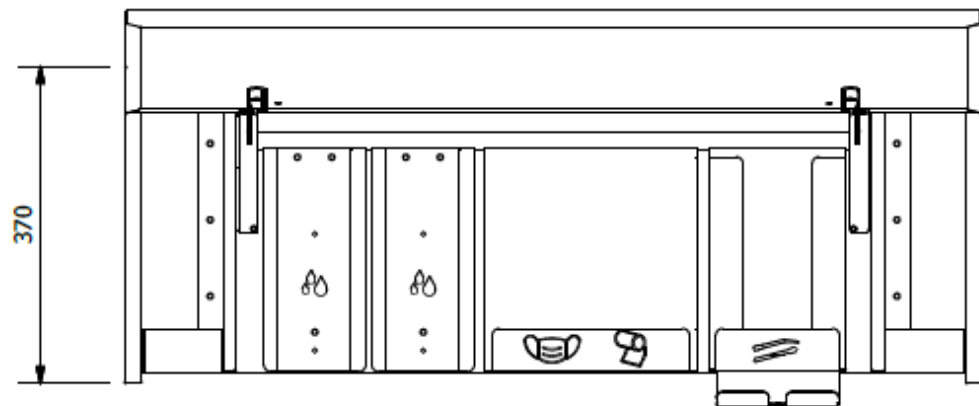

 **SARATOGA**

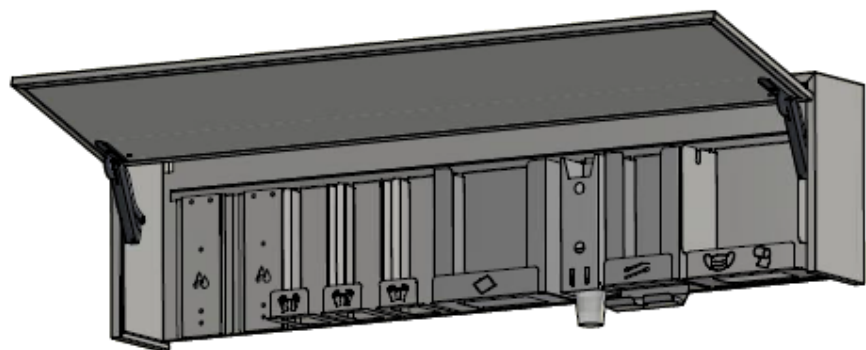
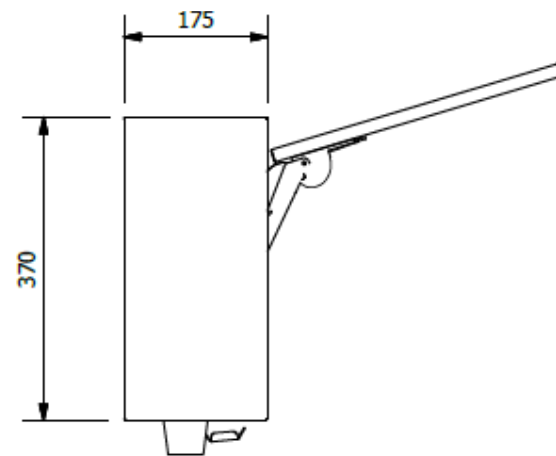
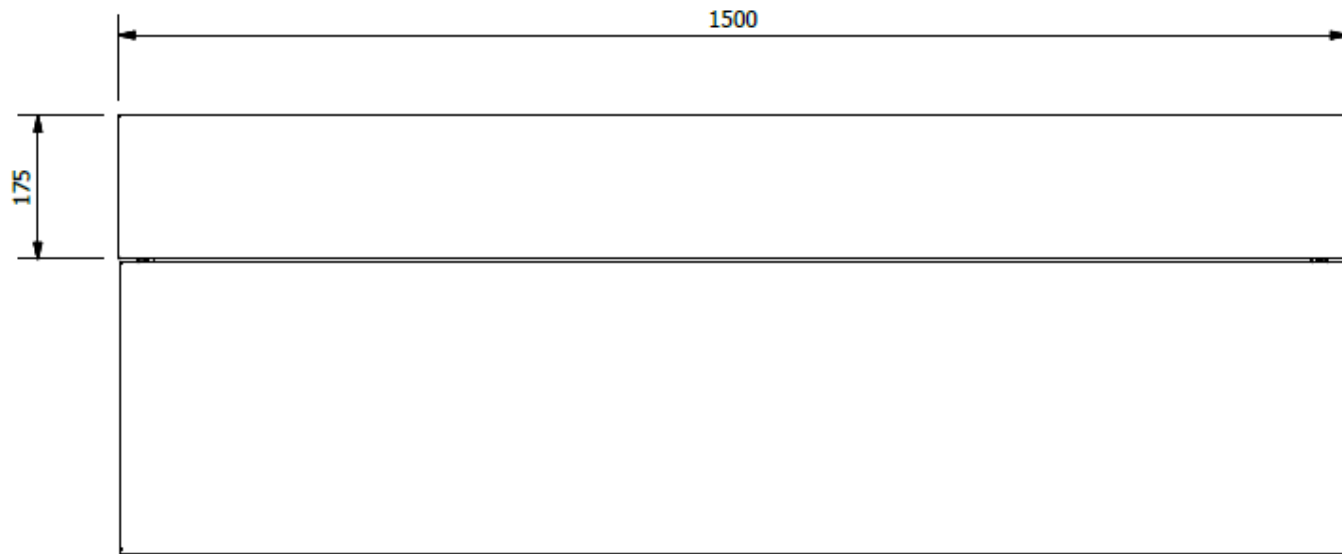
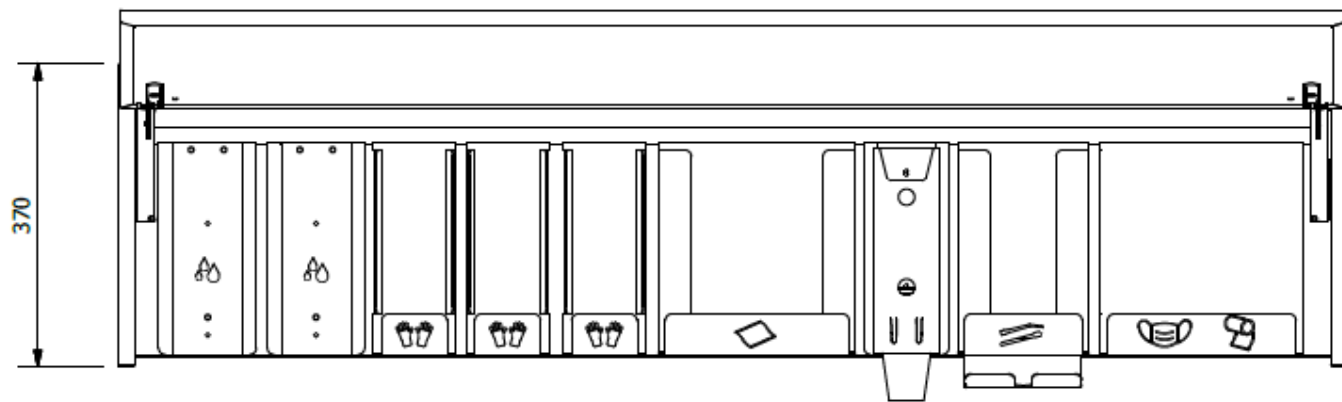

S_KY ACCESSORIES

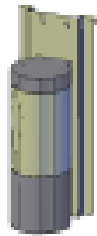

0,5 LT LIQUID
DISPENSER SUPPORT
MODULE

S_KY A001

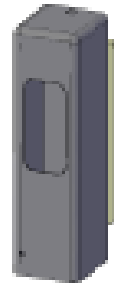

1,0 LT GEL
DISPENSER
SUPPORT
MODULE

S_KY A004



GLOVES BOX SUPPORT MODULE

S_KY A007

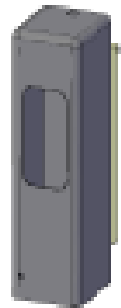

1,0 LT LIQUID
DISPENSER
SUPPORT
MODULE

S_KY A002

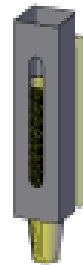

GLASSES SUPPORT
MODULE

S_KY A005

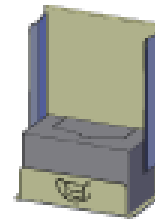

MASKS BOX SUPPORT
MODULE

S_KY A008



0,5 LT GEL DISPENSER
SUPPORT MODULE

S_KY A003

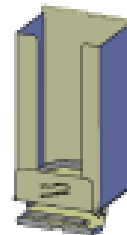

CANULAS SUPPORT
MODULE

S_KY A006



WIPES SUPPORT
MODULE

S_KY A009

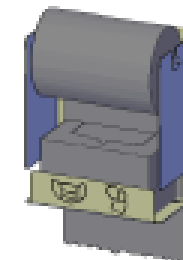

PAPER ROLL HOLDER
AND MASKS
SUPPORT MODULE

S_KY A010



Saratoga Srl
Via Savio 7
33170 Pordenone- Italy

